

# Standard Power MOSFET

P-Channel Enhancement Mode  
Avalanche Rated

**IXTH 11P50**  
**IXTT 11P50**

$V_{DSS} = -500 \text{ V}$   
 $I_{D25} = -11 \text{ A}$   
 $R_{DS(on)} = 0.75 \text{ } \Omega$

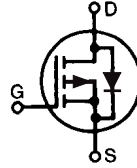

Symbol	Test Conditions	Maximum Ratings	
$V_{DSS}$	$T_J = 25^\circ\text{C}$ to $150^\circ\text{C}$	-500	V
$V_{DGR}$	$T_J = 25^\circ\text{C}$ to $150^\circ\text{C}$ ; $R_{GS} = 1 \text{ M}\Omega$	-500	V
$V_{GS}$	Continuous	$\pm 20$	V
$V_{GSM}$	Transient	$\pm 30$	V
$I_{D25}$	$T_C = 25^\circ\text{C}$	-11	A
$I_{DM}$	$T_C = 25^\circ\text{C}$ , pulse width limited by $T_J$	-44	A
$I_{AR}$	$T_C = 25^\circ\text{C}$	-11	A
$E_{AR}$	$T_C = 25^\circ\text{C}$	30	mJ
$P_D$	$T_C = 25^\circ\text{C}$	300	W
$T_J$		-55 ... +150	$^\circ\text{C}$
$T_{JM}$		150	$^\circ\text{C}$
$T_{stg}$		-55 ... +150	$^\circ\text{C}$
$T_L$	Maximum lead temperature for soldering 1.6 mm (0.062 in.) from case for 10 s	300	$^\circ\text{C}$
$M_d$	Mounting torque (TO-247)	1.13/10	Nm/lb.in.
Weight	TO-247 AD	6	g
	TO-268	4	g

TO-247 AD (IXTH)

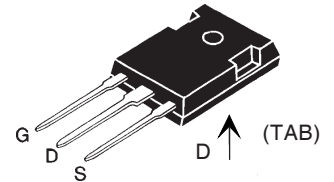

TO-268 (IXTT) Case Style

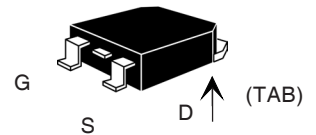

G = Gate                      D = Drain  
S = Source                    TAB = Drain

Symbol	Test Conditions	Characteristic Values ( $T_J = 25^\circ\text{C}$ , unless otherwise specified)		
		min.	typ.	max.
$V_{DSS}$	$V_{GS} = 0 \text{ V}$ , $I_D = -250 \text{ } \mu\text{A}$ $BV_{DSS}$ Temperature Coefficient	-500	0.054	V %/K
$V_{GS(th)}$	$V_{DS} = V_{GS}$ , $I_D = -250 \text{ } \mu\text{A}$ $V_{GS(th)}$ Temperature Coefficient	-3.0	-0.122	V %/K
$I_{GSS}$	$V_{GS} = \pm 20 \text{ V}_{DC}$ , $V_{DS} = 0$			$\pm 100$ nA
$I_{DSS}$	$V_{DS} = 0.8 \cdot V_{DSS}$ $T_J = 25^\circ\text{C}$ $V_{GS} = 0 \text{ V}$ $T_J = 125^\circ\text{C}$			-200 $\mu\text{A}$ -1 mA
$R_{DS(on)}$	$V_{GS} = -10 \text{ V}$ , $I_D = 0.5 \cdot I_{D25}$ $R_{DS(on)}$ Temperature Coefficient			0.75 $\Omega$ 0.6 %/K

## Features

- International standard packages
- Low  $R_{DS(on)}$  HDMOS™ process
- Rugged polysilicon gate cell structure
- Unclamped Inductive Switching (UIS) rated
- Low package inductance  
- easy to drive and to protect

## Advantages

- Easy to mount
- Space savings
- High power density

Symbol	Test Conditions	Characteristic Values ( $T_J = 25^\circ\text{C}$ , unless otherwise specified)		
		min.	typ.	max.
$g_{fs}$	$V_{DS} = -10\text{ V}$ ; $I_D = I_{D25}$ , pulse test	5	9	S
$C_{iss}$	$V_{GS} = 0\text{ V}$ , $V_{DS} = -25\text{ V}$ , $f = 1\text{ MHz}$		4700	pF
$C_{oss}$			430	pF
$C_{rss}$			135	pF
$t_{d(on)}$	$V_{GS} = -10\text{ V}$ , $V_{DS} = 0.5 V_{DSS}$ , $I_D = 0.5 I_{D25}$ $R_G = 4.7\ \Omega$ (External)		33	ns
$t_r$			27	ns
$t_{d(off)}$			35	ns
$t_f$			35	ns
$Q_{G(on)}$	$V_{GS} = -10\text{ V}$ , $V_{DS} = 0.5 V_{DSS}$ , $I_D = 0.5 I_{D25}$		130	nC
$Q_{GS}$			46	nC
$Q_{GD}$			92	nC
$R_{thJC}$	(TO-247)		0.42	K/W
$R_{thCS}$			0.25	K/W

Symbol	Test Conditions	Characteristic Values ( $T_J = 25^\circ\text{C}$ , unless otherwise specified)			
		min.	typ.	max.	
$I_S$	$V_{GS} = 0$	10P50 11P50		-10 -11	A A
$I_{SM}$	Repetitive; pulse width limited by $T_{JM}$	10P50 11P50		-40 -44	A A
$V_{SD}$	$I_F = I_S$ , $V_{GS} = 0\text{ V}$ , Pulse test, $t \leq 300\ \mu\text{s}$ , duty cycle $d \leq 2\%$			-3	V
$t_{rr}$	$I_F = I_S$ , $di/dt = 100\text{ A}/\mu\text{s}$		500		ns

### TO-247 AD Outline

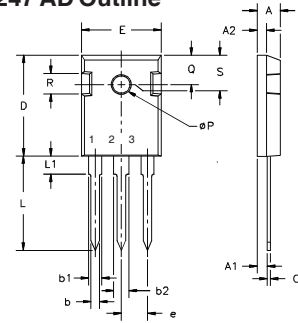

Terminals: 1 - Gate      2 - Drain  
3 - Source      Tab - Drain

Dim.	Millimeter		Inches	
	Min.	Max.	Min.	Max.
A	4.7	5.3	.185	.209
A <sub>1</sub>	2.2	2.54	.087	.102
A <sub>2</sub>	2.2	2.6	.059	.098
b	1.0	1.4	.040	.055
b <sub>1</sub>	1.65	2.13	.065	.084
b <sub>2</sub>	2.87	3.12	.113	.123
C	.4	.8	.016	.031
D	20.80	21.46	.819	.845
E	15.75	16.26	.610	.640
e	5.20	5.72	0.205	0.225
L	19.81	20.32	.780	.800
L <sub>1</sub>		4.50		.177
∅P	3.55	3.65	.140	.144
Q	5.89	6.40	0.232	0.252
R	4.32	5.49	.170	.216
S	6.15	BSC	.242	BSC

### TO-268 Outline

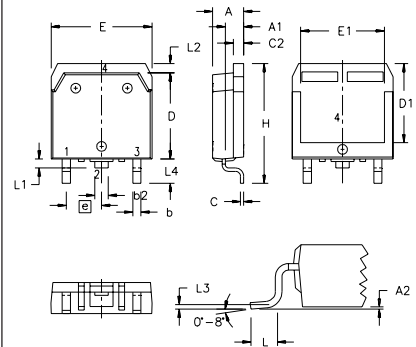

Terminals: 1 - Gate      2 - Drain  
3 - Source      Tab - Drain

SYM	INCHES		MILLIMETERS	
	MIN	MAX	MIN	MAX
A	.193	.201	4.90	5.10
A <sub>1</sub>	.106	.114	2.70	2.90
A <sub>2</sub>	.001	.010	0.02	0.25
b	.045	.057	1.15	1.45
b <sub>2</sub>	.075	.083	1.90	2.10
C	.016	.026	0.40	0.65
C <sub>2</sub>	.057	.063	1.45	1.60
D	.543	.551	13.80	14.00
D <sub>1</sub>	.488	.500	12.40	12.70
E	.624	.632	15.85	16.05
E <sub>1</sub>	.524	.535	13.30	13.60
e	.215 BSC		5.45 BSC	
H	.736	.752	18.70	19.10
L	.094	.106	2.40	2.70
L <sub>1</sub>	.047	.055	1.20	1.40
L <sub>2</sub>	.039	.045	1.00	1.15
L <sub>3</sub>	.010 BSC		0.25 BSC	
L <sub>4</sub>	.150	.161	3.80	4.10

IXYS reserves the right to change limits, test conditions, and dimensions.

IXYS MOSFETs and IGBTs are covered by one or more of the following U.S. patents:	4,835,592	4,931,844	5,049,961	5,237,481	6,162,665	6,404,065 B1	6,683,344	6,727,585
	4,850,072	5,017,508	5,063,307	5,381,025	6,259,123 B1	6,534,343	6,710,405 B2	6,759,692
	4,881,106	5,034,796	5,187,117	5,486,715	6,306,728 B1	6,583,505	6,710,463	6,771,478 B2

**Fig. 1. Output Characteristics  
@ 25 Deg. C**

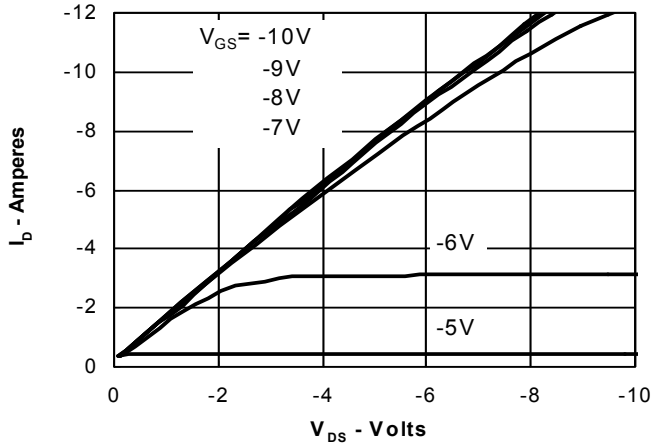

**Fig. 2. Extended Output Characteristics  
@ 25 Deg. C**

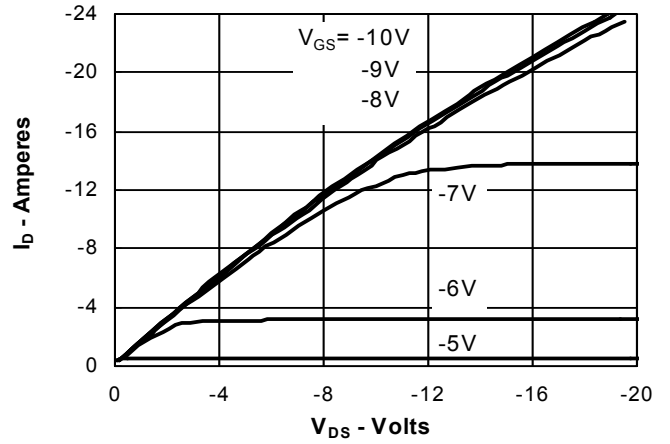

**Fig. 3. Output Characteristics  
@ 125 Deg. C**

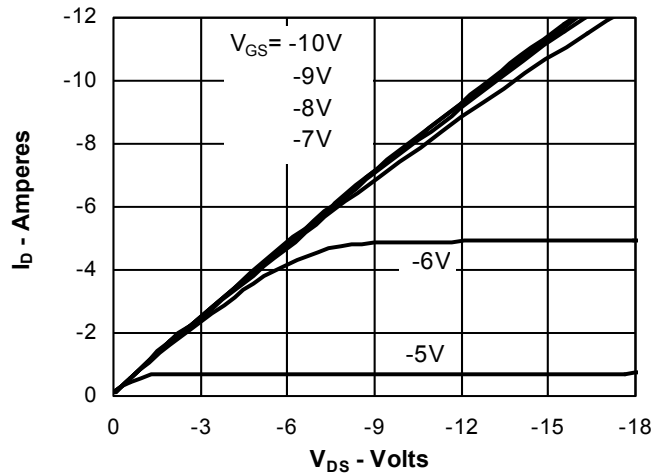

**Fig. 4.  $R_{DS(ON)}$  Normalized to  $I_{D25}$  Value  
vs. Junction Temperature**

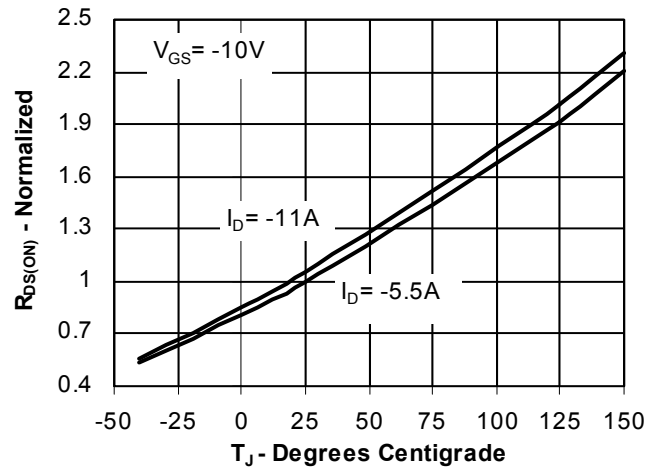

**Fig. 5.  $R_{DS(ON)}$  Normalized to  $I_{D25}$   
Value vs.  $I_D$**

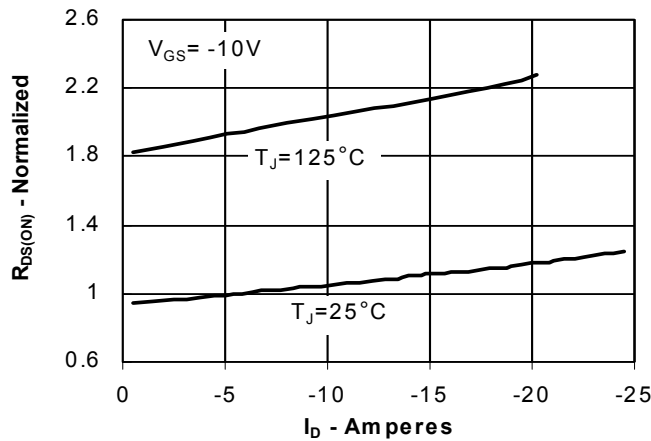

**Fig. 6. Input Admittance**

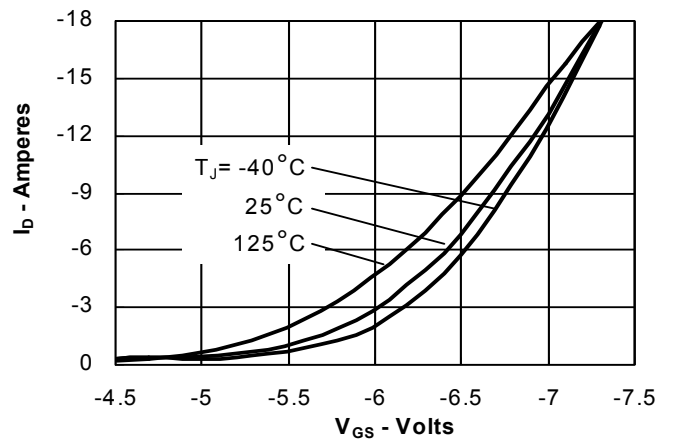

Fig. 7. Transconductance

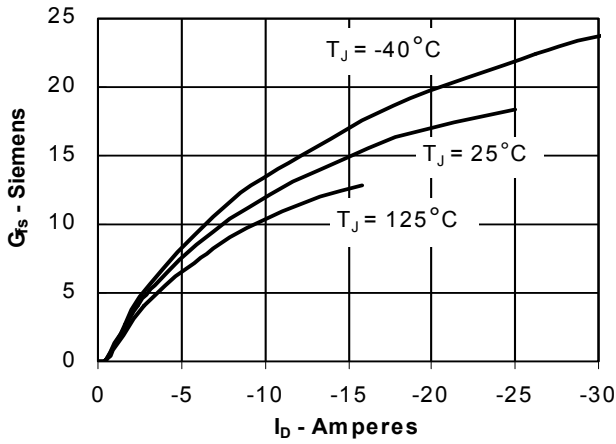

Fig. 8. Source Current vs. Source-To-Drain Voltage

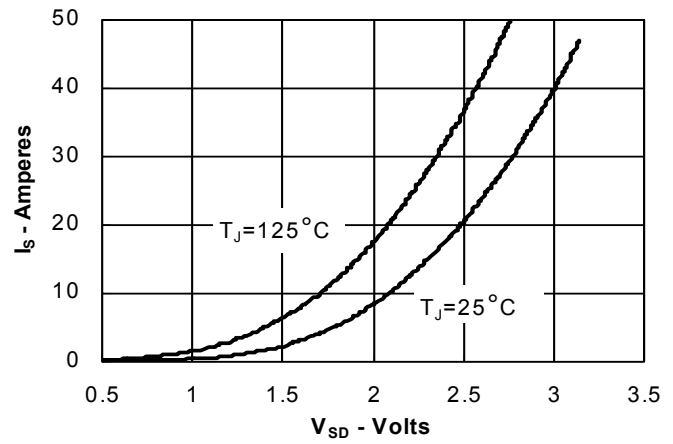

Fig. 9. Gate Charge

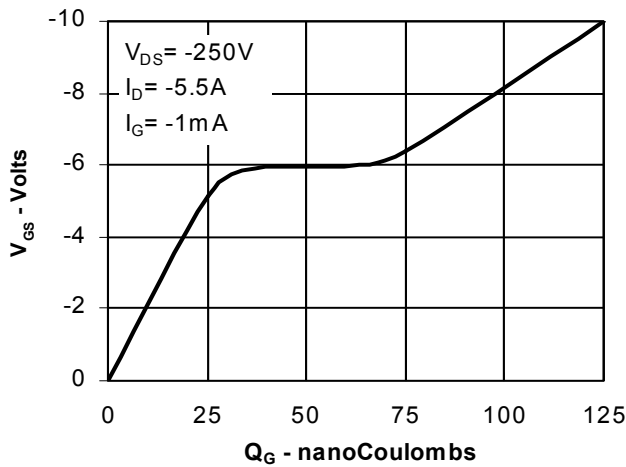

Fig. 10. Capacitance

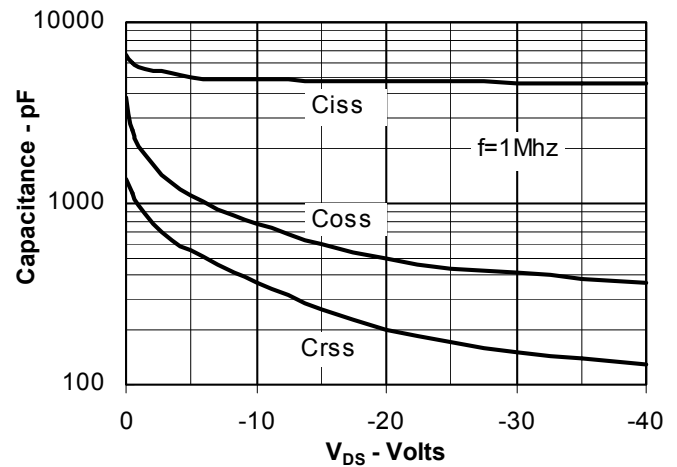

Fig. 14. Maximum Transient Thermal Resistance

